

JAKI®

MAKER

POP

潮想造物

YOLO ENERGY
URBAN LIFESTYLE

BE YOURSELF
BE YOUR OWN BOSS
BE YOUR OWN STAR



White
Sneakers

青春白球鞋

8+

2种拼法 乐趣加倍



佳奇以积木复刻经典潮鞋，特设左右两种拼搭方法，只需集齐两款，即可配对一双。精致尺寸，既能把玩于掌心，又能作时尚装饰品。

实用笔筒&花盆



潮鞋内凹的鞋口可作为笔筒或收纳，置于桌面，便于工作学习。还可内置泥土，变成潮鞋小花盆，一“鞋”多用。



朋克红球鞋

热血激昂的朋克红搭配炫酷黑，燃动赛场热血精神。



赤道绿球鞋

潮酷的造型搭配大面积的复古绿，古典与新潮的时尚碰撞。



A

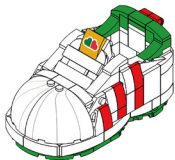

搭建视频教程

A1

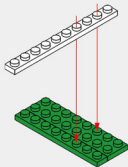
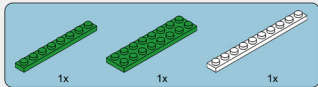

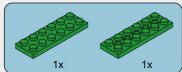

A2

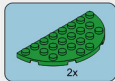
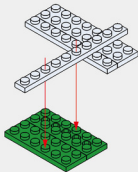

A3



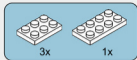

A4

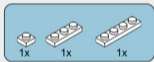
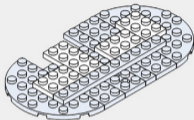

A5

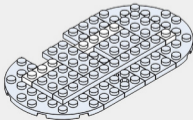

A6

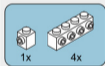
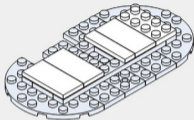

A7

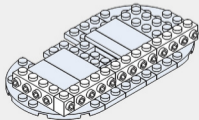



A8-1 (多肉花盆用途请
按A8-1步骤拼搭)



按A8-1步骤拼搭)

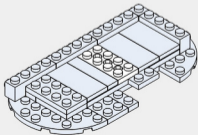

A8-2 (笔筒用途请按A8-2
步骤拼搭)



步骤拼搭)

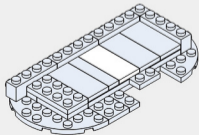

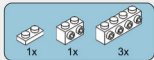

A9

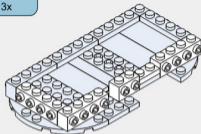

A10

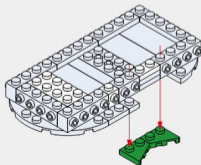

A11

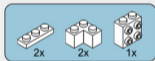
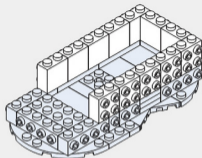

A12

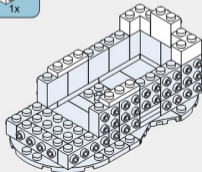

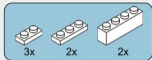

A13

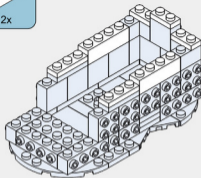

A14

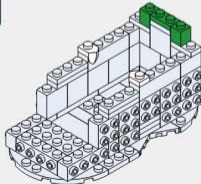

A15

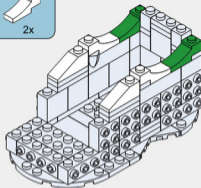

A16

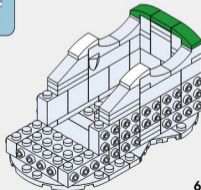

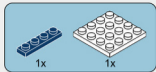

A17

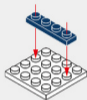

A18



A19



A20

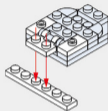

A21

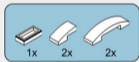
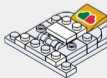

A22

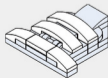

A23

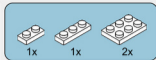
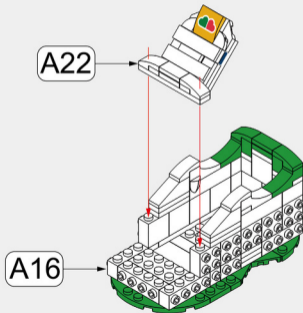

A24

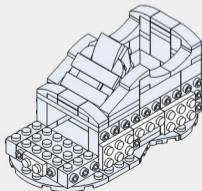

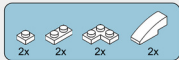

A25

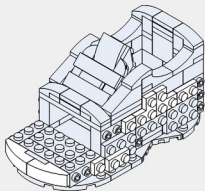

9



A26

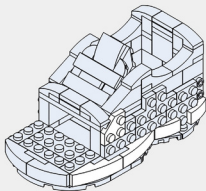



A27

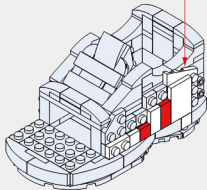
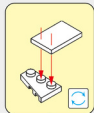

A28

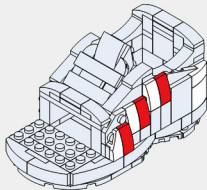

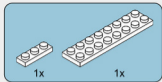

A29

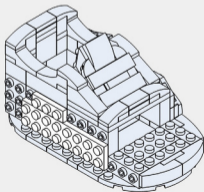

A30

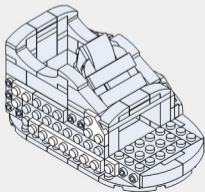

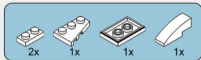

A31

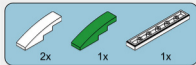
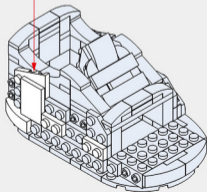
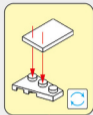

A32

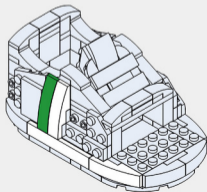



A33

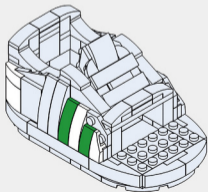

13

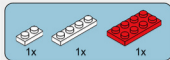

A34

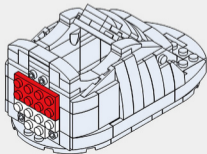



A35

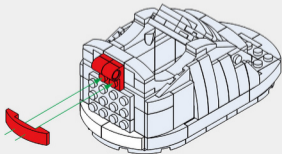

A36

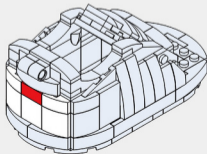



A37

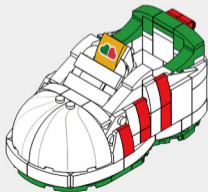
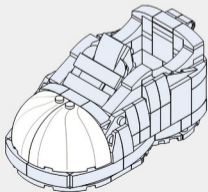

B

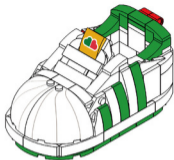

1x



1x

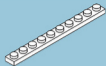

1x

B1

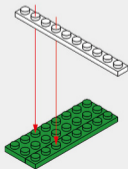

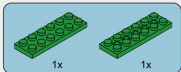

B2

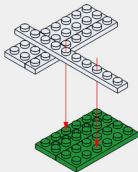

17

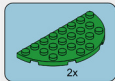

B3





B4

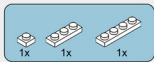
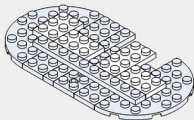

B5

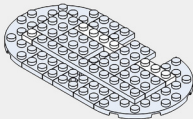

B6

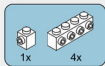
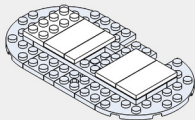

B7

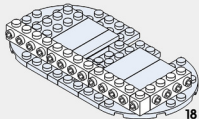



B8-1 (多肉花盆用途请
按B8-1步骤拼搭)



按B8-1步骤拼搭)

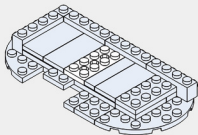

B8-2 (笔筒用途请按B8-2
步骤拼搭)



步骤拼搭)

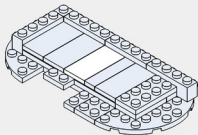

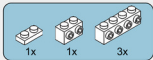

B9

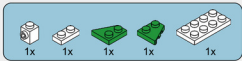
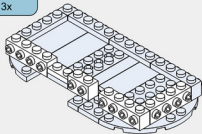

B10

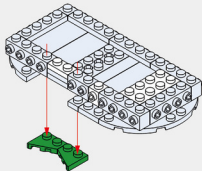

B11

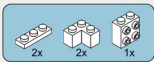
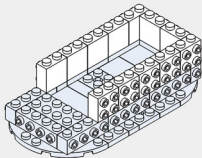

B12

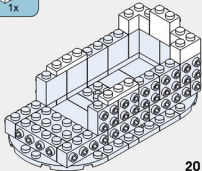

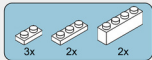

B13

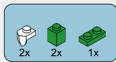
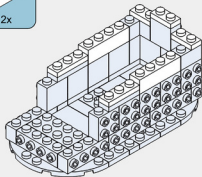

B14

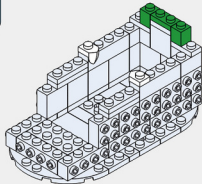

B15

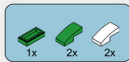
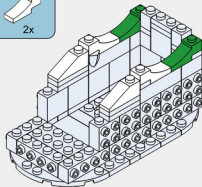

B16

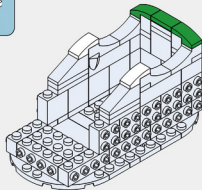

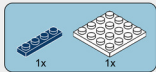

B17



B18



B19



B20

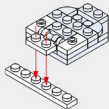

B21

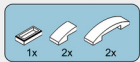
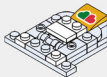

B22

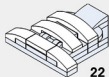

B23

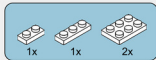
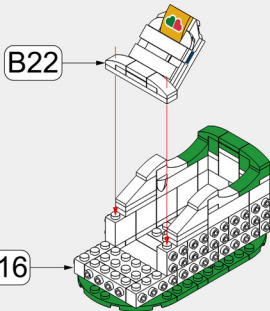

B24

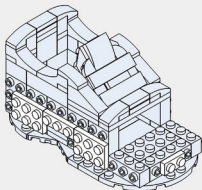



B25

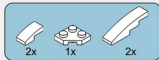
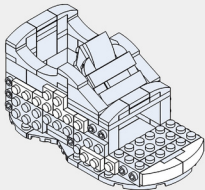

B26

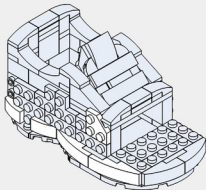



B27

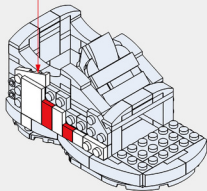
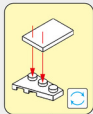

25



B28

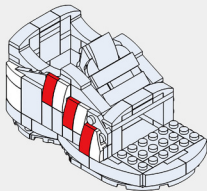

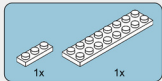

B29

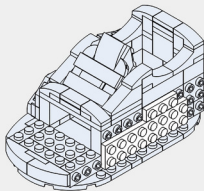

B30

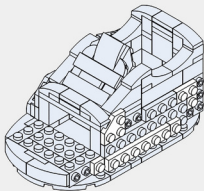

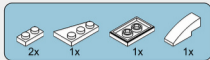

B31

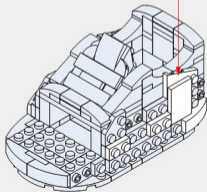
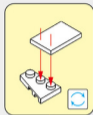

27

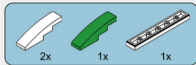

B32

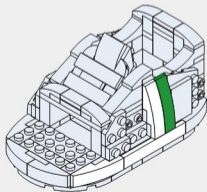

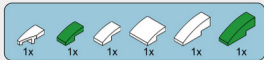

B33

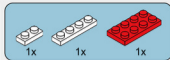
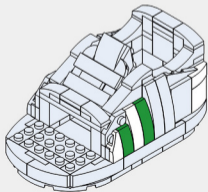

B34

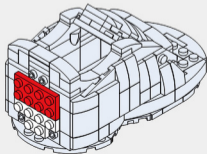



B35



B36

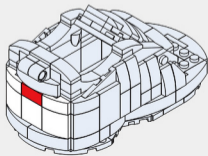
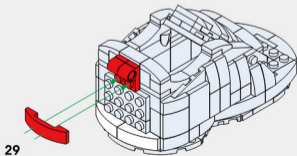



B37

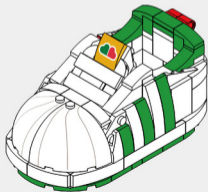
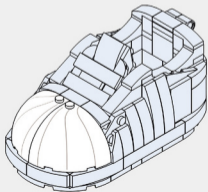

JAKI®



积木补件



售后服务



产品资讯



JK8201 青春白球鞋



JK8202 朋克红球鞋



JK8203 赤道绿球鞋